



Lifting Eye Nut RUD RM

Product information

Octagonal lifting eye approved for lifting. Lifting with an angle of inclination is allowed with reduction of WLL (see diagram at blueprint) but we strongly recommend using the RUD RM lifting eye only for straight lifting.

Applied harmonized norms: DIN EN ISO 12100: 2011-03

Material: Forged high tensile steel

Marking: According to standard, CE-marked, WLL

Temperature range: -40° up to 200°C (no reduction of WLL)

Standard: EN 1677-1





Warning: RUD RM eye nuts are only to be used with bolts or threaded studs with a min. quality class 8.8 and who are 100 % crack detected. Non certified bolts or threaded studs are not allowed.

Safety factor: 4:1

Grade: 8

Part code	WLL ton	Thread mm	WLL 90° ton	A mm	B mm	C mm	D mm	E mm	T mm	Weight kg
421100040230	0.4	M6	0.1	12	11	10	25	25	34	0.1
421100080230	0.8	M8	0.2	12	11	10	25	25	34	0.1
421100100230	1	M10	0.25	12	11	10	25	25	34	0.1
421100160230	1.6	M12	0.4	14	13	12	30	30	41	0.2
421100200230	3	M14	0.75	16	15	14	35	35	48	0.3
421100320230	3.2	M16	0.8	16	15	14	35	35	48	0.3
421100480230	4.8	M18	1.2	18	17	16	40	40	55	0.4
421100600235	6	M20	1.5	18	17	16	40	40	55	0.35
421100800235	8	M24	2	22	21	20	50	50	70	0.6
421101200230	12	M30	3	28	26	24	60	60	85	1.3
421101600230	16	M36	4	40	43	38	90	100	130	5.65
421102400230	24	M42	6	40	43	38	90	100	130	5.4
421103200230	32	M48	8	40	43	38	90	100	130	5.3

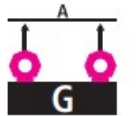
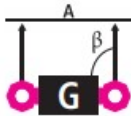
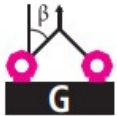
Technical data

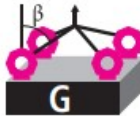
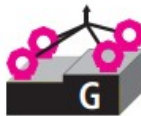
Method of lift								
Number of legs	1		2		2		3/4	
Angle of inclination β	0°	90°	0°	90°	$0^\circ-45^\circ / 45^\circ-60^\circ$	unsymm.	$0^\circ-45^\circ / 45^\circ-60^\circ$	unsymm.
Factor	1		2		1		1.5	
Metric type	RUD-Eyenut -WLL in metric tonnes, bolted							
RM- M6		0.4 t	0.1 t	0.8 t	<p>For these kind of lifting purposes we recommend lifting points which can be adjusted to direction of pull!!</p>			
RM- M8		0.8 t	0.2 t	1.6 t				
RM- M10		1 t	0.25 t	2 t				
RM- M12		1.6 t	0.4 t	3.2 t				
RM- M14	M14x1.5	3 t	0.75 t	6 t				
RM- M16	M16x1.5	3.2 t	0.8 t	6.4 t				
RM - M18	M18x1.5	4.8 t	1.2 t	9.6 t				
RM- M20 + M22	M22x1.5	6 t	1.5 t	12 t				
RM- M24 + M27	M24x2 / M27x2	8 t	2 t	16 t				
RM- M30 + M33		12 t	3 t	24 t				
RM- M36		16 t	4 t	32 t				
RM- M39		20 t	5 t	40 t				
RM- M42		24 t	6 t	48 t				
RM- M48	M48x3	32 t	8 t	64 t				

Blueprint

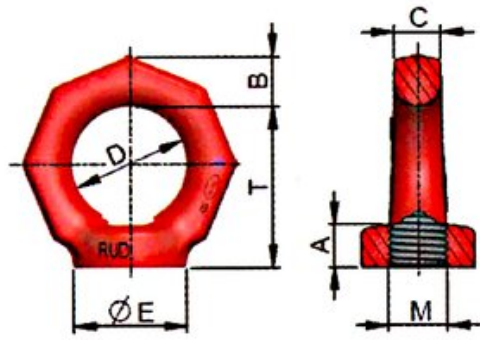

Lifting Method			
Angle of inclination β	0°	90°	0°
WLL Factor	1	0.25	2
For these lifting methods we recommend lifting points which can be adjusted to the direction of pull!			